

Custom Fit: Is it fit for the customer?

Penelope A. Watkins



**First published in Great Britain in 2006 by IFFT1
as a CD Rom. ISBN number: 978-1-903455-09-8
Additional copies of this publication are available
from:**

**Research Office
London College of Fashion
20 John Princes Street
London
W1G 0BJ**

**Price £3.00 (excluding postage)
Cheques made payable to
University of the Arts London**

Abstract

Body scanning information for virtual personalisation and mass customisation in the garment production process is forging ahead. A major difficulty discussed in this paper is garment fit; the production of better fitting clothes would significantly increase consumer satisfaction and reduce garment returns. Although the current limitations of automated measurement extraction will be minimised in time, the process, in itself, cannot provide mass custom fit.

Garment fit satisfaction is subjective, encompassing physical and psychological factors.

Fit generally relates to the garment design/style and it is then left to the customer to interpret how closely the garment should conform to the body. Traditionally garment fit is determined by the interpretation of derived measurement data to produce pattern drafting co-ordinates that reflect the 'ideal' customer size/shape profile. The process contains an implicit fit rationale, which can produce a disparity between actual body shape and proportions, and the pattern geometry.

Body shape, the different proportions between the form, width and length of body segments, is key. Garment sizing/fit and its infinite variables impose on one's body cathexis; the self-evaluation of body image satisfaction/dissatisfaction. Garment fit expectations are problematic, the intended garment-to-body fit relationship and body shape proportions/size indicators need clarification. To aid clarity I have introduced the terms distal and proximal fit, which describe the proximity of the garment to the body.

Other problematic areas include automated landmarking, incomplete anthropometric body scanning data, and readily transposable haptic/virtual 2D/3D pattern design coordinates.

Virtual garment fit (an integral part of the e-business strategy) is intended to increase confidence in custom fit. However if the custom fit garments supplied are produced through adapting traditional pattern design parameters then the proffered fit is only a coincidental fit. Therefore, in this context, can custom fit be fit for the customer?

Body shape, the different proportions between the form, width and length of body segments, is key. Garment sizing/fit and its infinite variables impose on one's body cathexis; the self-evaluation of body image satisfaction/dissatisfaction.

1. Introduction

The demand for stretch garments has increased significantly. The focus of this paper is on body contouring stretch garments. Fit satisfaction is subjective and encompasses physical and psychological factors. Garments designed as anti-fit are outside the scope of this paper. Garments are chosen to meet our needs and desires, although good fit is a major consideration it is one of the many contributory factors to individual comfort and freedom. The development of form fitting stretch garment technology has a vital contribution to make in developing a whole range of custom fit clothing products.

Applications include Sports and leisurewear, medical and wellbeing, and intimate bodywear.

Pattern drafting techniques for woven block patterns are well established. Relatively, stretch pattern technology is in its infancy. Applying traditional techniques to generate patterns for stretch fabrics can be successful, but it is often at a cost. In garments with conventional pattern co-ordinates, the looser the fit means a greater number of body shape anomalies can be accommodated. Conversely the tighter a garment is, the greater the garment to body fit disparity. Although this is not always apparent when observing stretch garments (without visualising the curvilinear distortion of the stretch fabric as it contours the body) as some inconsistencies can be absorbed within the stretch fabric parameters.

It does not necessarily hold true that to pattern design for stretch fabric, using the simplified shape of modified conventional patterns will automatically give an acceptable contour fit. Dissatisfaction with the fit of stretch garments is exacerbated through movement. The stretch fit is affected by anchor or grip points, which restrain the fabric. A typical example is a stretch T shirt, where during movement, the fabric rides up to grip under the arms causing the fabric to wrinkle horizontally across the chest and poke (an excess of fabric) at the shoulder/sleeve crown. To feel comfortable and maintain an aesthetically pleasing contour silhouette the garment has to be pulled down after movement. Customise or not, examples of ill-fitting stretch garments are numerous, exercise short leggings, underwear that rides up or down. It's frustrating to discover in an exercise class after a few moves the uncomfortable redistribution of stretch fabric. The time I've heard 'I'm just the wrong shape for this garment!'

2. Garment Fit

The term garment fit can either refer to the design/style or the proximity of the garment to the body. Custom fit refers to the individuals fit within the design /style. Garment fit in this context describes the proximity of the garment to the body on a *distal proximal fit continuum* with the body contour as the zero proximal reference point (Watkins 2005).

The greater positive value towards the distal reference point the looser the garment fit becomes and conversely as the garment compresses the body the greater the positive proximal value becomes. For clarity garment fit has been approximated into three values either side of the zero proximal point along the distal proximal fit continuum.

2.1 Distal Fit

Garments along the distal continuum away from the proximal fit describe garments that are constructed from fabrics that are either non-stretch or have minimal stretch to enhance comfort.

These garments are essentially an external structure ranging from a *Loose Fit (D6)* through *Semi-fitted (D4)* to *Fitted (D2)*.

The hypothesis presented is that the stretch pattern profile geometry (the proximal range) and the fabric stretch parameters are co-determinants in producing custom body-form fitting stretch garments.

2.2 Proximal Fit

The proximal fit describes body-contouring garments constructed in a stretch knit fabric.

The increasing positive proximal fit is related to the garment pattern reduction ratio, influenced by the force exerted on the body, through the modulus or compressive retracting power of the stretch fabric. On the distal proximal fit continuum the proximal fit attributes as follows:

Form Fit (P0) describes garments that have few wrinkles and no stretch other than tare stretch (a minimal amount) in specific areas, to allow the fabric to smoothly contour the body. The stretch fabric exerts no pressure on the body and the stretch does not impede mobility. An example would be close fitting underwear with no holding power.

Cling Fit (P2) includes fashion garments where the fabric stretch does not significantly compress or alter the body contour. The stretch fabric clings to the body curves accentuating the natural shape, for example stretch T-shirts.

Action Fit (P4) describes garments where the retracting stretch effectively grips the body. Most stretch sportswear and exercise garments come under this heading and are produced in a diverse range of knit fabrics with differing degrees of stretch.

Power Fit (P6) refers either to the garment as a whole or to specific areas where the force exerted by the stretch holds and compresses the flesh, changing the body form shape.

Applications cover a wide range of sportswear, form persuasive bodywear and medical applications.

2.3 Fit Potential Hypothesis

The surface plot Table 1 illustrates the garment fit potential when conventional pattern co-ordinates are adapted. The stretch fabric parameters, referred to in this paper, only come into play in the proximal fit range. The more body measurements taken should result in a higher fit potential. For a given number of measurements a better fit potential would be expected for distal fit. Similarly higher values of proximal fit should result in a poorer fit potential. The original pattern profile becomes increasingly distorted as the fabric is incrementally stretched around the body contours. It is the arbitrary garment-to-body fit relationship within the conventional pattern profile geometry that ultimately undermines the fit potential of custom fit stretch garments.

The hypothesis presented is that the stretch pattern profile geometry (the proximal range) and the fabric stretch parameters are co-determinants in producing custom body-form fitting stretch garments.

One has to question consensus of using adapted conventional pattern construction coordinates where arbitrary stretch fabric parameters are applied (Haggar 2004, Armstrong 1995, Aldrich 1996, 1997) is a good basis for developing stretch garment technology.

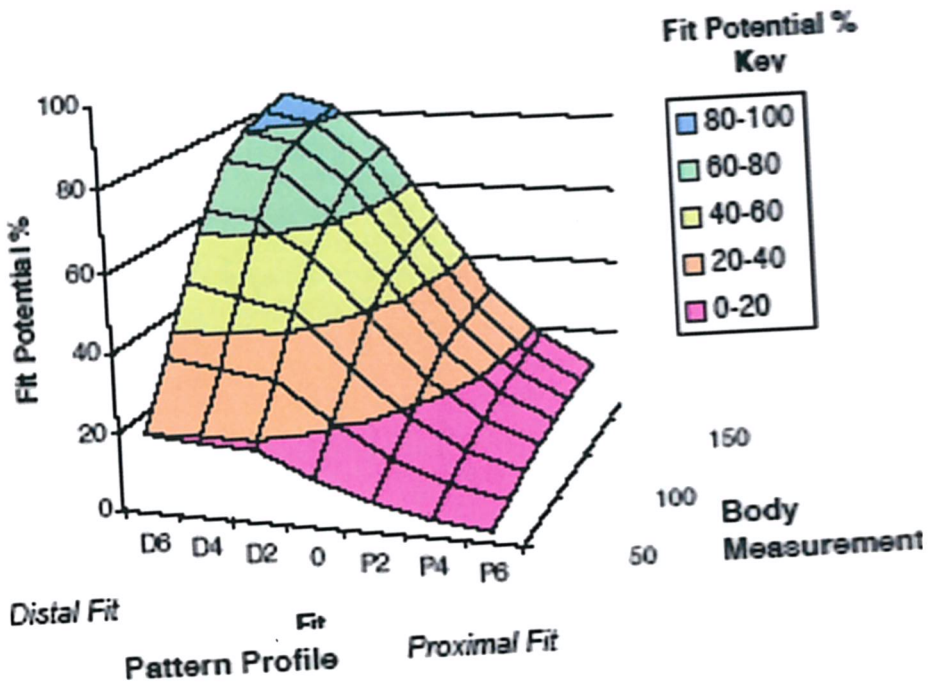

3. Evolution of the Garment Pattern

Traditionally women employed a dressmaker to make their gowns, with the exception of their riding habit, which was usually made by the tailor. Men's garments were custom made by tailors who were organised in craft guilds.

During the late 1800's the 'tailor-made' (a suit) became fashionable attire for women. The growth of the 'ready-to-wear' clothing industry heightened the need for pattern drafting systems, size charts and technical information to reproduce standardised garments. Empirical pattern drafting formulas (rules of thumb) emerged which could be adapted requiring minimal direct body measurements. In tailoring it is the desired silhouette, which is so vital, the architecture of the shoulders, the hang of the garment, the trousers constructed to stand (without needing body) in a perfectly aligned crease.

The garment construction around the body is padded and manipulated as the tailor strives to conceal the anomalies of the individual. The pattern cutter always seemed to have had a mental picture of the three-dimensional body whilst concurrently working in the two dimensional plane. The way in which patterns were manipulated and altered to fit is illuminating. In his book, 'The Practise of Garment Pattern Making', W. H. Hulme (1946) discusses the first principles of a pattern maker standing at the drafting board with a flat piece of paper lying before him: He has beside him a number of measurements, and in his mind there is an exact idea of the figure he is drafting for; how it stands and moves, its posture and action. On to that sheet of pattern paper he will place certain lines and many points; these points and lines will give the size and shape of the form.

Other lesser considerations will, of course, arise during the process, but size and shape are paramount. (Hulme 1946:23) The fashion for 'one size fits all' type of garment and the

decline in our manufacturing skills base has proved costly because this has meant that fundamental skills have been lost. Heuristic knowledge and haptic skills gained in clothing manufacturing processes were taught, felt, absorbed and applied often without a conscious recognition of the nuances of handling the relationship between the fabric, form (shape, posture, body movement) and the garment pattern cutting and grading process. Once those skilled people have been moved into other employment their tacit knowledge is lost. Most block patterns used by clothing manufacturers have been developed and adapted by numerous people over many years. This means that the rationale for implementing the pattern profile, the apportionment of body measurements and those applied measurements for tolerance or ease is often inaccessible.

3.1 Body shape and fit

What does the size on a label mean? Today in Britain, women's sizing systems are as baffling as ever! Size designations and measurement pictograms give no indication of the garment-to-body fit relationship or any clue as to the intended shape, proportions or posture of the target consumer. It is extremely difficult to standardise on garment sizing without first defining the garment-to-body fit relationship. This means that garments stating an actual body measurement for a specific size are impossible for the consumer to relate to without trying on the garment. Disparities between manufacturers sizing systems, is frustrating for the consumer who can vary up to three sizes in one trip visiting different retailers. The acceptance of garments of dubious fit, particularly stretch, garments appears to be almost obligatory. However a standard sizing system adopted by all manufacturers would mean less choice for consumers who did not conform to the designated body shape and measurements. Women may have similar circumferential measurements but can be vastly different in body shape, proportions and postures.

Body shape can be described by taking the different proportions between the form, width and length of body segments. In figure 1 the woman in the left is short, then there is a medium height and a tall woman. The torso can also differ in width from front to back and side to side as in figure 2. In both illustrations the women all have the same bust, waist and hip measurements, however, it clearly demonstrates body shape differences that need consideration in producing a custom fit.

There are numerous texts on fitting techniques for pattern construction for non-stretch garments; Liechty et al 1986, Bray 1978, Armstrong 1987, Rasband 1994, Wilson 1948 Hernandez 2000. Texts on fit and pattern alteration for stretch garments or the interaction of stretch characteristics with fit are rarely, if ever, included. Garment fit classification systems tend to focus on the 2D frontal body shape. Linking side views of body shape and posture is difficult as most do not automatically correlate to specific frontal classifications. Commonly used methods of figure analysis and garment fit have their own inadequacies and objectivity poses a major problem in self-analysis, peer analysis and virtual garment fit.

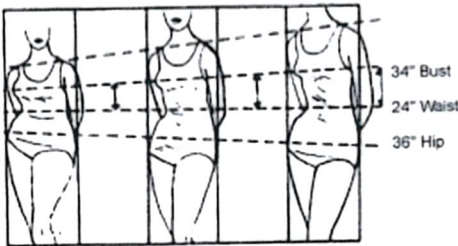

Figure 1: Variations in Body Shape and Proportions. Source: Horn (1991:369)

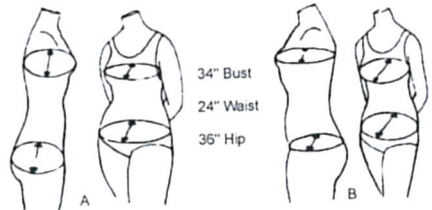

Figure 2: Variations in Body Shape and Proportions. Source: Horn (1991:369)

3.2 Anthropometry

In 1951 the Body Measurement Survey of British Women was undertaken. The clothing industry concluded that a reliable sizing system, based on scientific measurement data, would meet the needs of the customer (Kunick 1984). A government-sponsored survey of 5000 women published in 1957 became the basis for our modern sizing system. The 37 measurements taken manually gave no indication of body shape, proportion and posture. A more comprehensive anthropometric survey, Size UK, was completed in 2002 (Bougourd and Treleven 2002). 11,000 individuals of different genders age and ethnicity were scanned. A cloud point body map and 155 electronically taped measurements were recorded in a central database. Body scanning technology can be problematic as data from specific sites they may be missing or not be clearly visible (Fan et al.' 2004 pp164-165). Examples are the armpits, the crutch, under the chin, the bust and the shoulder areas, the contribution of sizing surveys to recording statistical information on changes in the human form is invaluable. However, this does not automatically bring about a better quality of garment fit.

3.3 Virtual Technology

The computer games industry has influenced the rapid growth of software development for more realistic human motion animation and fabric drape for the virtual catwalk. Major software vendors for the garment industry are working towards using virtual mannequins for garment design and production.

Body scanners can result in more reliable body measurements but only 85% of captured images can be landmarked automatically. (Wang 2005), but they have enabled generic feature based virtual mannequins to be developed. Virtual garment design whereby on screen creations can be electronically "sewn" and fitted to the mannequin in real time without the need to cut pattern pieces prior to final garment production is exciting.

Numerous texts are available on pattern design for non-stretch fabrics but few on pattern design for stretch fabrics. The consensus appears to be that modification of a traditional block pattern for woven fabric is the logical starting point for developing a block pattern for stretch fabric .

The published information regarding the efficiency of 3D pattern drafting software currently available from market leaders in the apparel industry is scarce. Because this process is highly dependant on pattern wrapping and pattern flattening techniques in the virtual body form fit realm, the software developed for stretch garments needs to be reverse engineered to objectively analyse the pattern profile geometry in relation to the physical body form and fabric parameters. Optimisation of the 2D pattern pieces will ultimately govern the quality of garment fit and whilst loose fitting garments allow a considerable degree of creative license, close fitting garments do not.

Available custom pattern design systems are predominantly based on computerised hand pattern production methods. A style pattern nearest in size to the client's own is adjusted by substituting the client's measurements at a few cardinal (specific points) on the pattern profile. Traditionally garment fit is determined by the interpretation of measurement data to produce pattern-drafting co-ordinates that reflect the 'ideal' customer size/shape profile. The process contains an implicit fit rationale, which can produce a disparity between actual body shape and the pattern geometry. The rationale for most traditional empirical pattern construction methods have been lost and we are just left with the rules.

The designated pattern profile to body contour relationship restricts personalisation of the garment pattern to within the rationale allowed by the original pattern design coordinates. Therefore the fit is not a truly personal one but a best-fit solution.

3D virtual pattern technology is progressing and in time will allow the designer, in real time, to successfully produce garments that fit the virtual and physical individual. The pattern flattening and pattern wrapping technique is dependant on construction coordinates and fabric parameters. Krzywinski et al (2005) suggest that 'The know-how of pattern construction is hardly necessary for these processes.' I contend that currently the technical aspect of stretch garment pattern design and fit is impoverished by a lack of information. The process will not be as transparent in the developed CAD system. Transparency of processes impels new paradigms in design development.

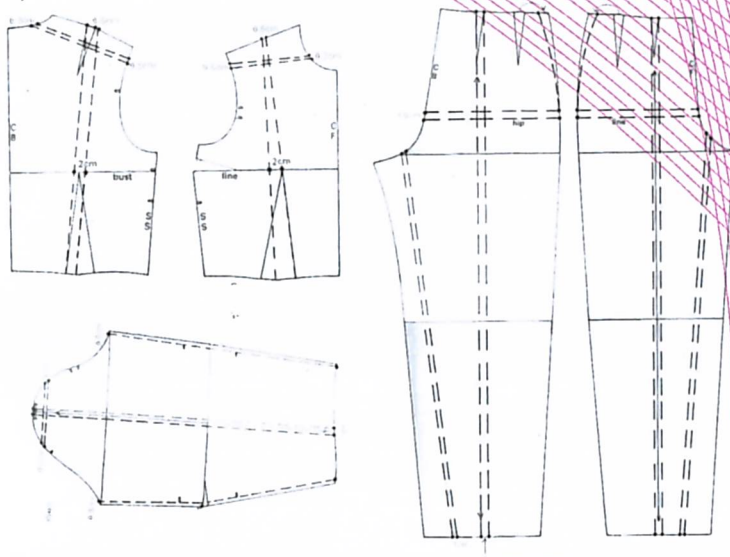

Figure 3: Modified Conventional Pattern.
 Source: Haggag (2004:249-250-253)

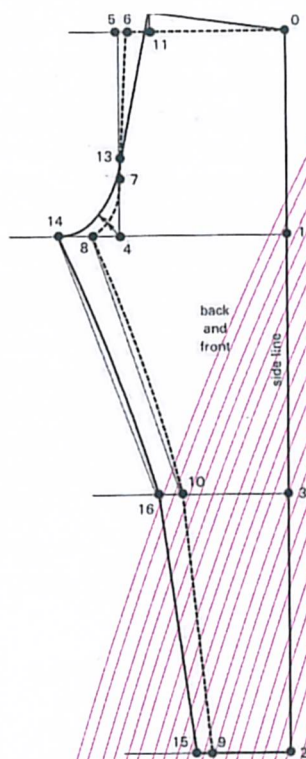
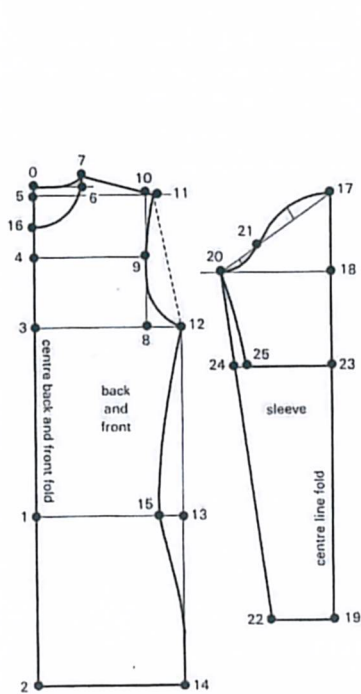

Figure 4: Rationalised Close Fitting Patterns. Source: Aldrich (1997:161)

4. Stretch Pattern Technology

Numerous texts are available on pattern design for non-stretch fabrics but few on pattern design for stretch fabrics. The consensus appears to be that modification of a traditional block pattern for woven fabric is the logical starting point for developing a block pattern for stretch fabric (Haggar 2004, Armstrong 1995, Aldrich 1996, 1997).

However, it has been ascertained that the reduced pattern profile geometry of a modified conventional block patterns (Figure 3) which has been rationalised (Figure 4) by approximating the pattern profile into straighter lines and more fluid curves is not always appropriate for a body contouring stretch garment.

Research modifying patterns based stretch fabric extensibility has been published Kirstein et al (1999) Ziegert and Keil (1988) Bönningheim (1996) Chun and Hue (1998).

Although the systems are based on fabric parameters the effect of garment-to-body stretch deformation, on the pattern profile, is not discussed or is computer generated Krzywinski et al (2001). Comprehension of the relationship between the dynamic body form, the flat pattern and the fabric stretch characteristics aids objective garment fit analysis and evaluation.

4.1 Assessing Stretch Extension Manually and Mechanically

There are stretch fabrics developed to suit every conceivable application. The range of fibre content and weights with varying stretch extension capacity is vast.

For the designer/pattern cutter, determining degree of stretch extension by manual or mechanical means is not a straightforward process. Theoretically it is the point at which the stretched fabric has reached its maximum extension without deforming the hard yarns or fibres (Murden 1966:356). Fabric stretch testing still requires subjective assessment of '*the useful limit of extension*' the effort exerted before resistance to stretch is reached, or the point at which a fabric becomes visually stressed.

The degree of stretch extension is measured against a rule and the sample is categorised as low, medium or high stretch. This is not a satisfactory approach as results are arbitrary without determining the force applied.

Texts outlining manual/mechanical methods to quantify the degree of stretch extension vary significantly on the sample width, length and load. Aldrich (1996:27) mechanised the hand stretch method in an attempt to objectively assess fabric extension.

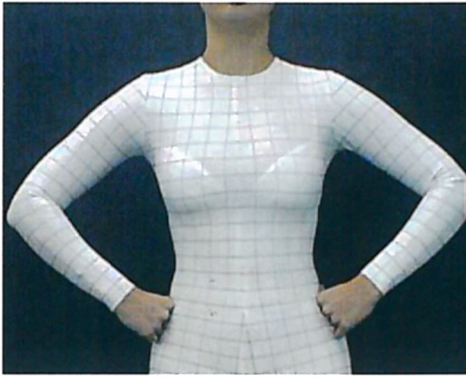

Figure 5: Visual Analysis of Stretch Fabric to Body Front Curvilinear Distortion.
Source: Watkins (2000)

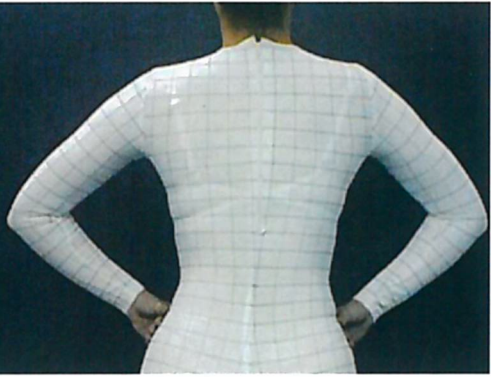

Figure 6: Visual Analysis of Stretch Fabric to Body Back Curvilinear Distortion.
Source: Watkins (2000)

Most manufacturers tend to state a single averaged course/wale stretch figure, usually attributed to a range of fabrics but this can be misleading as it is not generally stated that the degree of stretch is obtained by applying differing loads to the individual fabrics. This averaged stretch figure is inadequate for stretch pattern design (Ziegert and Keil 1988:56).

Standard Tests used by fabric and fibre producers and garment technologists assess the fitness for purpose of a garment fabric and have specific quality assurance parameters in common. British BS 4952 (1992) and the American ASTM D1775 (1994) standard tests include methods for: fatiguing or ageing specimens; determining extensions at a specific force, modulus, tension decay, residual extension, fatigue set, elastomeric thread break and runback. None of the tests are suitable for pattern technology.

The development of consistent and verifiable test methods resulting in industry standards has engendered its own common language between fabric and garment technologists. The same level of integration between stretch fabric producers/technologists and pattern technologists/designers is needed for stretch pattern technology. With the lack of useful data on fabric stretch extension for pattern reduction it comes down to subjective experience, but this cannot be readily translated into a CAD system.

The development of consistent and verifiable test methods resulting in industry standards is needed to introduce objectivity into the stretch pattern process.

4.2 Stretch Garment Analysis

Understanding the complex relationship between the stretch fabric characteristics and the pattern profile geometry can be enhanced through objective stretch garment fit analysis.

Uneven stretch distribution is not visually apparent without analysing the garment-to body curvilinear stretch distortion characteristics (Watkins 2000). The analysis garment (Figures 5 and 6) a stretch body suit has no darts or inserts to accommodate the body curves and hollows. 25mm gridlines delineated on the analysis toile allows the designer to visualise stretch deformation over the body contours. The square deforms into the different geometric shapes, rectangles, rhomboids, and trapezoids, which illustrate local fabric distortion by highlighting:

- The direction of stretch relative to the pattern straight grain line
- The stretch distortion of each square. Gridlines not only enable the observer to identify areas of unacceptable stretch, which is indicative of the pattern profile being incorrect, but also they confirm that the horizontal and vertical toile/body placement aligns as the designer intended.



Figure 7: Action Fit: Movement Analysis

4.3 Pattern Reduction and Garment Pressure

There is little information on where and by how much to reduce the block pattern profile geometry in order to stretch and contour the body comfortably without fabric displacement. Patterns are, by nature, irregular and contain areas where there will be a non-linear relationship between relaxed length and the required stretch. The critical areas are the shoulders, the bust, under the arm, the seat angle, the bodyrise, the fork point and the thigh, which need to be reassessed for potential impact on pattern geometry.

The application of a uniform stretch reduction factor is not always appropriate. The factors affecting the pressure of the fabric on the body are the tissue density resistance to pressure and the radius of the part being covered. If the degree of fabric stretch is maintained at a constant level then the tension in the fabric will remain constant.

As body mass decreases, the pressure on the body exerted by the fabric will increase. Limited available stretch can affect comfort.

The effect of radius of curvature may necessitate adjustment of the pattern profile, particularly towards the extremities.

4.4 Movement Analysis

Evaluating the fit stretch characteristics of the toile in its 3D form in the context of a functional movement matrix is enlightening. Learning how to fit to an acceptable standard for stretch contoured garments, as with any design development, is a cyclical step-by-step process, building technical skills based on practical experience.

The fit relationship is complex and a more representative fit analysis and evaluation is conducted on a subject rather than a dress stand. The assessment takes place after the garment has warmed up and a series of movements, which fully articulate the body and the fabric, have been performed (Figure 7).

Body heat affects the fibres in fabric causing them to relax and mould to the body. On cessation of movement the fabric adjusts to reach equilibrium in contouring the body.

A factor that may contribute to women's dissatisfaction with the body is that fashionable clothing reflects a standard they do not fit. When clothing does not fit, the consumer may perceive the cause as related to the body and not the clothing, with resulting negative feelings about the body.

5. Body Cathexis

Because fashion is marketed to the young with representations of the body ideals as tall and slim those of us who are not the ideal have absorbed the idea that garments of dubious fit are to be expected. Somehow we are not the right shape for the garment!

A stretch garment that follows the body contours closely allowing complete freedom of movement, is fashionable and conforms to the requirements of a specific activity, sporting or otherwise, should enhance self-esteem. However, the contoured stretch garment still engenders dissatisfaction. LaBat and DeLong in their study 'Body Cathexis and Satisfaction with Fit of Apparel' suggest that: A factor that may contribute to women's dissatisfaction with the body is that fashionable clothing reflects a standard they do not fit. When clothing does not fit, the consumer may perceive the cause as related to the body and not the clothing, with resulting negative feelings about the body. (LaBat and DeLong 1990:43)

The development of objective stretch garment technology would have significant benefits. It is the relationship between the body shape, proportions, stretch fabric behaviour and the construction of the garment pattern geometry that impels the quality of the garment fit. Stretch garment-to-body fit disparities, can often be the root cause of negative body cathexis. Garments that constantly have to be rearranged in order to feel more comfortable only add to dissatisfaction with the fit. Therefore, no matter what the clothing application is, the importance of fit to enhance psychological and physical comfort is crucial for self-esteem.

7. References

- Aldrich, W.** (1996) *Fabric, Form and Flat Pattern Cutting*. Oxford: Blackwell Science Ltd
- Aldrich, W.** (1997) *Metric Pattern Cutting*. 3rd Ed Oxford: Blackwell Science Ltd
- Armstrong, H.** (1995) *Patternmaking for Fashion Design*. 2nd Ed. USA: Harper Collins Publishers
- American Standard** (1996) **ASTM** Designation: D 4964-96 Standard Test Methods for Stretch Properties of Knitted Fabrics Having Low Power. USA: ASTM Standards, pp. 641-645.
- Bonnigheim** (1996) *Passformsicherheit fur Bodies und mehr. Bekleidung*, vol 21, p 29.
- Bougourd, J.P. and Treleaven, P.C.** (2002). *Capturing the Size of the Nation: Size UK*. IFFT International Conference, Hong Kong
- Bray, N.** (1978) *Dress Fitting*, 2nd Ed Oxford, Blackwell Science.
- British Standard** (1992) BS 4952 : 1992 *Methods of Test for Elastic Fabrics*, UK, British Standards Institute, pp. 1-12.
- Chun, J. and Hue, J.H.** (1998) *Development of Bodice Patterns Modifications System Based on the Stretch Rate of Knit*. ITAA Proceedings, USA, pp 110-111.
- Fan, J. Yu, W. and Hunter, L.** (2004) *Clothing Appearance and Fit: Science and Technology*. Cambridge: Woodhead Publishing
- Hagggar, A.** (2004) *Pattern Cutting for Lingerie, Beachwear and Leisurewear*. 2nd Ed, Oxford: BSP Professional Books
- Hernandez, N.** (2000) *Tailoring the Unique Figure*, Research report 30, Gotternberg University, Sweden
- Horn, M.J. and Gurel, L.M.** (1981) *The Second Skin. An Interdisciplinary Study of Clothing*, 3rd Ed London, Houghton Mifflin Company.
- Hulme, W.H.** (1946) *The Practice of Garment-Pattern Making*, London, National TradePress Ltd.
- Ibrahim, S.M.** (1968) *Mechanics of Form-Persuasive Garments Based on Spandex Fibers*. *Textile Research Journal*, September, pp 950-963
- Kirstein, T. Krzywinski, S. and Rodel, H.** (1999) *Pattern Construction for Close-Fitting Garments made of Knitted Fabrics*. *Melliand Textilberichte*, vol 80, pt 3, March, pp E46- 48/146-148
- Krzywinski, S. Rodel, H. and Schenk, A.** (2001) *Links Between Design, Pattern Development and Fabric Behaviour for Clothing and Technical Textiles*. *JTATM*, NC State University, vol 1, issue 4
- Krzywinski, S. and Rodel, H.** (2005) *Virtual Product Development for Close-Fitting Garments of Knitwear with Elastan Yarns*. 2nd International Conference of Textile Research Division NCR. Cairo, Egypt. April 11-13
- Kunick, P.** (1984) *Modern Sizing and Pattern Making for Women's and Children's Garments*. London: Philip Kunick Publications.

RESPONSE ADDRESS:

Dr Penelope Watkins
Research Fellow
London College of Fashion
University of the Arts London
20 John Prince's Street
London
W1G 0BJ

Email: p.a.watkins@fashion.arts.ac.uk
Website: www.fashion.arts.ac.uk

LaBat, K.L. and DeLong, M.R. (1990) Body Cathexis and Satisfaction with Fit of Apparel, Clothing and Textiles Research Journal, vol.8 (pt.2), Winter, pp.43-48.

Liechty, E.G. Pottberg, D.N. and Rasband, J.A. (1986) Fitting & Pattern Alteration: A Multi-Method Approach, USA, Fairchild Publications.

Murden, F.H. (1966) Elastomeric Thread Review (II): Elastomer and Fabric Test Method. Textile Institute and Industry, vol 4, December, pp 355-358

Rasband, J. (1995) Fabulous Fit, USA, Fairchild Publications.

Watkins, P.A. (2000) Analysis of Stretch Garments. Textile Institute 80th World Conference, Manchester, April

Watkins, P.A. (2005) Custom Fit Pressure Garment Pattern Profiling. Wearable Futures: Hybrid Culture in the Design and Development of Soft Technology conference. University of Wales September

Wang, C.C.L. (2005) Parameterization and parametric design of mannequins. Computer- Aided Design, vol.37, no.1, pp.83-98,

Wilson, J. (1948) The Art of Cutting & Fitting, London, Crosby Lockwood & Son Ltd.

Ziegert, B. and Keil, G. (1988) Stretch Fabric Interaction with Action Wearables: Defining a Body Contouring Pattern System. Clothing and Textiles Research Journal, vol 6, pt.4, Summer, pp 54-64

