

# **Error Chain Analysis - An Effective Method for Tighter Manufacturing Process Control**

James Dockree and Qian Wang

School of Mechanical and Design Engineering, University of Portsmouth, UK

[james.dockree@myport.ac.uk](mailto:james.dockree@myport.ac.uk), [qian.wang@port.ac.uk](mailto:qian.wang@port.ac.uk)

Regina Frei\* -- Corresponding author

Southampton Business School, University of Southampton, UK

[work@reginafrei.ch](mailto:work@reginafrei.ch)

**Abstract**

One of aims of manufacturing quality control is to ensure that products are made free from defects according to specifications without unnecessarily increasing-time and cost of production. Over-control of a process can be as detrimental to a manufacturer as under-control. It is common in industry that operators use their personal knowhow and intuition to decide where to implement process verification, and where to tighten it when processes are not meeting specifications. This is partially because there is little scientific guidance that can assist operators in making a decision on levels of quality control of a process at varying stages. To remedy this, a new method for manufacturing quality control, namely Error Chain Analysis (ECA), is introduced and its application is illustrated in this article. ECA is capable of statistically analysing the quality of a multi-stage manufacturing process based on existing control measures, and it enables to indicate where added or tighter control may need to be effectively implemented. For testing its applicability, ECA was built into a user-friendly tool that was subsequently used to analyse data gathered from a large manufacturing company in the UK.

**Keywords**

Quality control, quality assurance, FMEA, manufacturing, production

## 1 Introduction

Process control has become an integral part of quality management in modern manufacturing industry. Shewhart (1926) pioneered “the formulation of a scientific basis for securing economic control” by developing statistical quality control, and Rissik (1943) developed this further. In the decades since, many new methods of controlling quality have been produced. The most common quality control (QC) methods were critically assessed to understand the potential benefits and drawbacks, pointing out the aspects that an alternative method would need to cover. The ultimate aim was to identify any areas of the present theory that lack an ‘engineering approach’ and answer the question: “How can the exact percentage of control of a manufacturing process be calculated?” Subsequently, a new quality control method was developed and implemented in a tool to assess the quality of the manufacturing processes used in the case study company. The information gained can then be used to highlight the points in the manufacturing process that most require additional control. The ‘engineering approach’ is the application of logic, mathematics, science and empirical evidence to solve a problem to an appropriate level of accuracy. In the case of quality control, the appropriate level of accuracy that is required is debated as it often depends on the specific application.

The case study company is a global market and technology leader in Engineered Joining Technology solutions, with over 60 years of manufacturing and product-development experience. With almost 9000 employees, it has a global network of manufacturing facilities and numerous sales and distribution sites across Europe, the Americas and Asia-Pacific. The company manufactures a very comprehensive range of joining-technology products in the clamp, connect and fluid categories. The UK branch is specifically responsible for the manufacture of two styles of clamp, the QRC (quick release clamp) and the VPP clamp both with a dozen sub types. The company is a high turnover business, producing approximately 100,000 clamps every week with a high focus on quality. Some of their clients are automotive retailers such as Volvo and Ford. As they have strict demands on quality, the company must therefore uphold the highest level of quality in order to maintain an advantage over their competitors.

ECA was developed as a method of assessing the quality of a manufacturing process that removes the need for human decisions when tactically implementing control. Based on the review of literature and an analysis of industrial requirements, a new method may need to meet the following criteria:

- It provides an accurate assessment of the level of control that exists in a process and the chance of failure of these controls, similar to Failure Modes and Effects Analysis (FMEA).
- It is capable of identifying all potential sources of failure from known and unknown combinations of errors.
- It can generate an exact answer to the question: “Where is it best to increase control and by how much?”
- It does not require advanced software tools, high computing power or advanced mathematical analysis as these are all barriers to implementation.
- It enables the analysis of an entire multi-stage manufacturing process as a whole instead of focussing on each stage separately.
- It should also work based off of both estimated “predictive” data and collected “reactionary” data, similar to Failure Tree Analysis (FTA).

## 2 Related work

Quality control in manufacturing processes used to be human-centered and based on production engineers intuitively knowing where processes needed improving (Paul and Yan, 1984). In spite of modern technology, there is still an element of this in today's quality control. A vast array of approaches and methods of controlling quality have been developed to aid manufactures both set and reach quality targets. The following review of the literature assesses the most popular QC methods and existing methods of measuring manufacturing performance.

**Statistical Process Control (SPC)** is a method of monitoring and improving a process that requires data to be gathered over time. Control charts are generated in order to check for process stability and can swiftly identify when a process is no longer in control and quality has dropped. This information can be used to react and find the source of the instability, be it a change to the process or an external factor. As pointed out by Oakland (2008), the key advantage of SPC over other control methods is that it minimises the interruption to production. This is because an appropriate sampling frequency can be identified and implemented as part of the method resulting in less interruption. Although it is very useful to have a method that can quickly indicate when there is a drop in quality, as noted by Woodall (2000) and Gordon (2019), SPC cannot identify the source of the issue nor can it identify where to add additional controls in order to combat it. Ong et al. (2004) found that when using statistical control charts, the human performance of using these tools is a critical factor that needs to be taken into account when creating graphical interfaces. Most process quality assurance methods focus on measuring the outcomes of a certain process, and compare the results with the specification. Hamrol (2000) suggested a method to help the operator determine the most useful sampling frequency.

**Taguchi Methods**, which have been developed since the 1950s, are statistical methods that increase the quality in manufacturing processes (Roy, 2010), using robust parameter / tolerance design and the use of Gauss' loss function to quantify quality in terms of divergence from the target. To minimize production costs, it is more important to reduce deviation from customer-defined targets rather than just aiming to meet specifications. Taguchi methods can complement SPC.

**Failure Mode and Effects Analysis (FMEA)** is used for risk assessment of potential failure modes of a system, design or process. The method involves assessing known failure modes and all potential effects of these, with each gaining a Risk Priority Number (RPN). When carrying out a risk assessment, there are far reaching benefits to using FMEA's structured approach of splitting a multi-stage process down into separate stages with each failure mode and their causes identified (Pantazopoulos and Tsinopoulos, 2005). However, there are limitations to the method (Joshi and Joshi, 2014; Johnson and Khan, 2003): FMEA can fail to identify previously unknown potential errors with a system. Also, the generated RPN is an arbitrary value that merely indicates points of high risk and does not provide any assessment of the cost to quality of these risks. Last but not least, the assigning of Occurrence and Detection levels can require lengthy debate as the definitions can be vague. A real world quality control process in manufacturing industry requires decisions to be made on what extra controls to add and where to add them. These tactical decisions are often the sticking point of quality control. Although FMEA is one of the commonly used methods for determining the existing flaws of a manufacturing process or the design of a product, FMEA is not a substitute for quality engineering - it is a supplement. Also, FMEA can magnify the efficacy of the knowledge and experience of cross functional team when reviewing a process or design by assessing its risk of failure.

Weaknesses of FMEA:

- FMEA may not be able to identify the risk of a complex failure that consists of multiple failures. This is because FMEA focuses on failure modes rather than effectively review a process including input and output features that also need to be considered.
- RPN are not a precise statistical evaluation of risk. It can only be used to compare different scenarios and not effectively assess them on an individual basis.
- The assignment of detection and occurrence levels can take significant time to allocate and it is often inconsistent. This can be mitigated by creating and enforcing standard definitions for detection and occurrence levels, as suggested by the Ford Design Institute (2011) in their FMEA Handbook.
- FMEA documents can contain a lot of repeated information.

Some studies proposed approaches to improve FMEA for certain specific applications. Examples include: Knowledge-enriched Process FMEA (Zheng et al., 2002), FMEA with pairwise comparison to establish the relative importance of the input factors through the risk priority number calculation, Markov chains to estimate risk distributions in the long term (Brun and Savino, 2018) and a version where the concept of failure was replaced with the concept of defect (Paciarotti et al., 2014).

Process Failure Mode and Effect Analysis (PFMEA) is a subtype of FMEA that provides a structured approach to identifying the deficiencies and failures of a process that affect its reliability, the output product's quality and subsequently the customer's satisfaction. This is achieved by assessing the materials used, human factors involved, as well as the set up and condition of the machines used. These are assessed for their chance of producing an error (occurrence) and the chance of errors being found (detection). Recently, PFMEA has been integrated with LEAN tools and principles (Banduka et al., 2016).

■ **Fault Tree Analysis (FTA)** provides a probabilistic evaluation of faults, often in safety and economically critical systems (Ruijters and Stoelinga, 2015). It is a quantitative method that involves translating a physical system into an organised logic diagram (fault tree), where identified causes (branches) lead to one selected fault (top event/trunk). FTA shares many similarities with FMEA and as such they have overlapping uses. FMEA can be easier and cheaper to implement when reviewing smaller systems, however FTA may be better for more complex systems where all the causes of potential failure modes are not immediately obvious. The biggest issues with FTA are the time it takes to implement and the inability in FTA to cater for a combination of events without advanced software packages (Akgün et al., 2015).

■ **Total Quality Management (TQM)** is an approach to quality that advocates the continuous detection of errors and subsequently their elimination, optimizing supply chains, ensuring employee training that is effective and improving customer satisfaction (Ross, 2017). TQM requires full, company-wide commitment to the program in order to meet with success (Karuppusami and Gandhinathan, 2006). This level of commitment is not necessarily required by other quality control strategies and limits the usefulness of TQM as any lack of effort or resources can undermine the whole TQM program.

■ **Six sigma** uses five core principles; Define, Measure, Analyse, Improve and Control (DMAIC) to ensure that products have zero defects and meet customers' needs. Achieving a Six Sigma level means that a mistake is only made 3.4 times in a million. Most companies achieve positive returns once they have implemented a Six Sigma program (Anthony et al., 2012), but it

requires an even higher level of company-wide commitment than TQM. Tsou and Chen (2005) built a method for achieving quality that takes into account the cost of producing poor quality products as well as the cost for implementing quality improvements. Six Sigma may benefit from the development of more realistic project payback models that highlight which controls are most useful in which situations (Brady and Allen, 2006).

Table 1 provides an overview of the uses and weaknesses of popular QC methods.

Table 1: Applications and weaknesses of the key QC methods

Methods	Applications	Summary of weaknesses
<b>SPC</b>	Identifying when errors arise with a system	Unable to identify the source of the issue; unable to pinpoint where to add additional controls to combat the issue
<b>Taguchi Methods</b>	Quantifying quality and optimizing parameter design	Hard to implement and the process can be slow and time consuming
<b>FMEA</b>	Risk assessment of potential failures	Can miss sources of error and the calculated risk values are arbitrary
<b>FTA</b>	Risk assessment of potential failures	Time-consuming to implement and cannot cater for a combination of events without advanced software packages
<b>TQM</b>	Creating a strategy to manage quality	Requires full commitment to successfully achieve quality goals
<b>Six Sigma</b>	Method of providing continuous improvement of quality	Requires company-wide full commitment and the potential improvements of the implemented controls cannot be assessed before implementation

**Other methods:** Davrajh and Bright (2013) developed a quality management system for product families in mass customization and reconfigurable manufacturing, where processes and product requirements are variable. Mhada et al. (2011) proposed a fluid model with mixed good and defective parts, combining the descriptive capacities of continuous / discrete event simulation models with analytical models, experimental design, and regression analysis. It is suitable for cases with constant demand rates and exponential failure and repair time distributions of the machines.

Human operators often play an important role in achieving high quality levels in manufacturing processes. For instance, Michalakoudis et al. (2018) suggested to get operators to understand the functions of the parts they were making in an attempt to improve manufacturing quality. However, rather than relying on fuzzy human factors, a more practical approach, which leads to consistent results, needs to be created.

**Engineering approaches to quality control:** *Reactionary engineering* is the traditional approach. It is the use of gathered data to react to an issue after it has occurred by correcting the source moving forward. *Predictive engineering* relies on methods like FTA attempting to identify the roots of failures before they occur. However, the use of computational power to predict the exact occurrence of errors is an emerging field. Rossiter (2017) presented the methods of model-based predictive engineering and provided an overview of these new predictive quality control methods. Ordieres-Meré et al. (2012) also carried out an assessment of predictive quality control, pointing out that their complexity can be a barrier to implementation without developing effective strategies and advanced algorithms.

In summary, there are many methods of appraising and monitoring the quality of a process and suggesting when to improve it and by how much. However, there is no method that can suggest exactly where in a complex, multi-stage process to add controls in order to achieve a desired improvement to quality. This is usually left to the assessment of engineers based on their experience and essentially new controls and sensors are added based on educated guesses. The engineering approach to this should be to understand exactly what impact a new control will have before implementing it.

### **3 Error Chain Analysis**

Error Chain Analysis (ECA) takes into account the inputs and outputs of each process step, and it can indicate where exactly added quality monitoring would be most effective. To test its applicability, ECA was applied to an industrial case study as illustrated in Section 5.

#### ***3.1 Single Stage Process Modelling***

ECA consists of five steps-as described subsequently.

##### *Step 1: Identifying input and output features of a process*

The manufacturing process must be surveyed in detail to identify all the key input and output features. The example uses a blanking process, where the programmed feed length of material to be cut (feed length) is an input, and the length of metal cut (blank length) is an output.

##### *Step 2: Categorising features*

Each feature should be categorised as either Product, Process Set Up or Process Condition. This will help break down the process into sections that can be more easily assessed and all features that affect the end product can be more easily identified. As illustrated in Fig. 1, the input feed length of a blanking machine is a machine set up feature, the output blank length is a product feature, and the strip guides' wear is a machine condition feature.

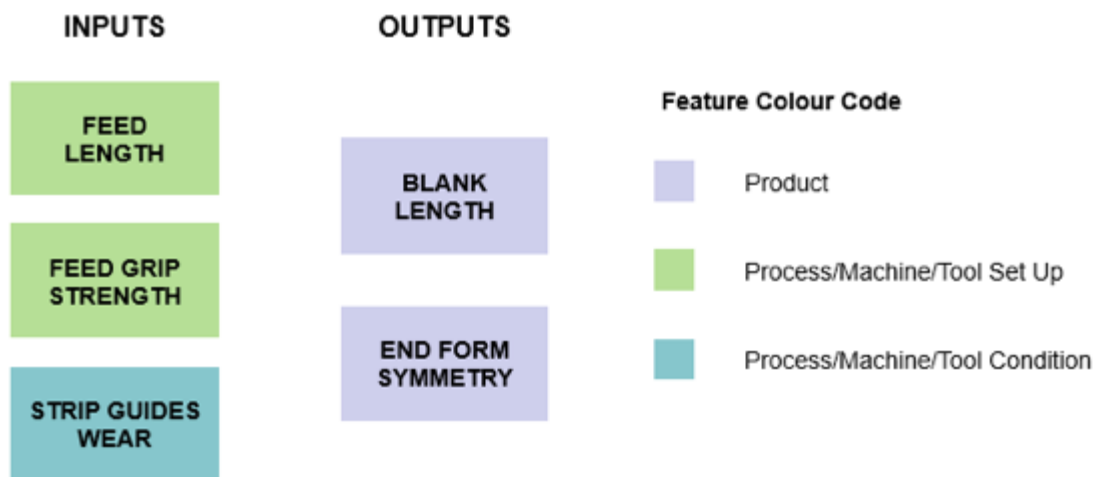

Figure 1: Diagram of a process' inputs and outputs with feature categories

*Step 3: Linking inputs to their dependent outputs*

Once a list of input and output features has been generated, their 'associations' can be identified. This can be achieved by picking an output and checking every input feature with the question: "Could this affect the selected output?" Example: The blank length is affected by both the set feed length and by the grip strength because if the grip fails, the blank will not be fed the correct length.

*Step 4: Assigning detection levels*

After all features have been identified, the control of these features must be assessed. Both the input and the output features of a process must have a detection level assigned. This is a more accurate way of modelling a process, unlike in FMEA, where only the failure mode will be given a detection level. It is highly beneficial to use standard definitions for each detection level when surveying a process as this will regulate the approach taken by any surveyor and it will speed up the survey. The philosophy of this method is that there is one correct answer and any engineer should be able to approach the same problem and reach the same answer. Therefore, this method has adopted the Ford Design Institute FMEA standard definitions for detection levels and occurrence levels (Ford Design Institute, 2011).

Shown in Fig. 2 as an example for the FFD with detection levels, the output blank length is measured on every piece by a light gate. According to the Ford standard definitions, the continuous thorough checking of a feature by use of a sensor is a level 3 control.

*Step 5: Assign occurrence levels*

Finally, the occurrence of errors with the input features must be assessed. This can either be done based on predicted data, measured data or a mixture of the two. However, the accuracy of data must be considered when assessing the results of the method.

After a survey it was found that the operators incorrectly set the blank length for 1 in every 100 parts produced which equates to a level 7 occurrence. Also new strip guides that are wear resistant were installed and it was estimated that they would only be responsible for an error 1 in 10000 parts – a level 2 occurrence. Fig. 2 represents the FFD with occurrence levels.



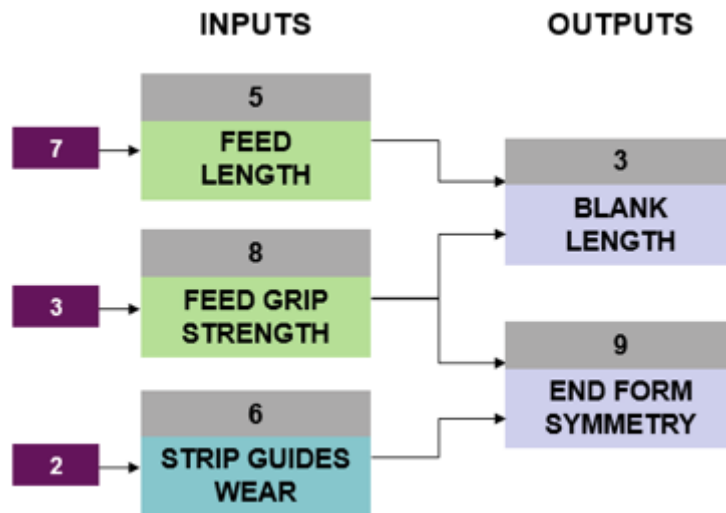

Figure 2: FFD with input occurrence levels

### 3.2 Multi-Stage Process Modelling

Unlike FMEA, which will approach each stage of a multi-stage process separately, ECA assesses the entire process as a whole. This is because stages in a process are not independent of each other and an error in one stage can carry through to the next.

The first stage of a process is assessed the same way as a single stage process. However, the output features of this stage then feed into the next stage as inputs. Therefore, subsequent stages will not require occurrence levels on every input feature, avoiding the double entry of data that is common when creating FMEA documents.

As an example, for a certain production process of a simple semi-circular metal strip, there are two stages: blanking and forming. The output arc length of the metal strip depends on the setup and condition of the forming press but it also depends on the length of the blank that was cut in the blanking stage. The blank length essentially has two detection levels, as it is measured post blanking and measured by the automated forming press. Fig. 3 shows the illustration of the multi-stage process FFD.

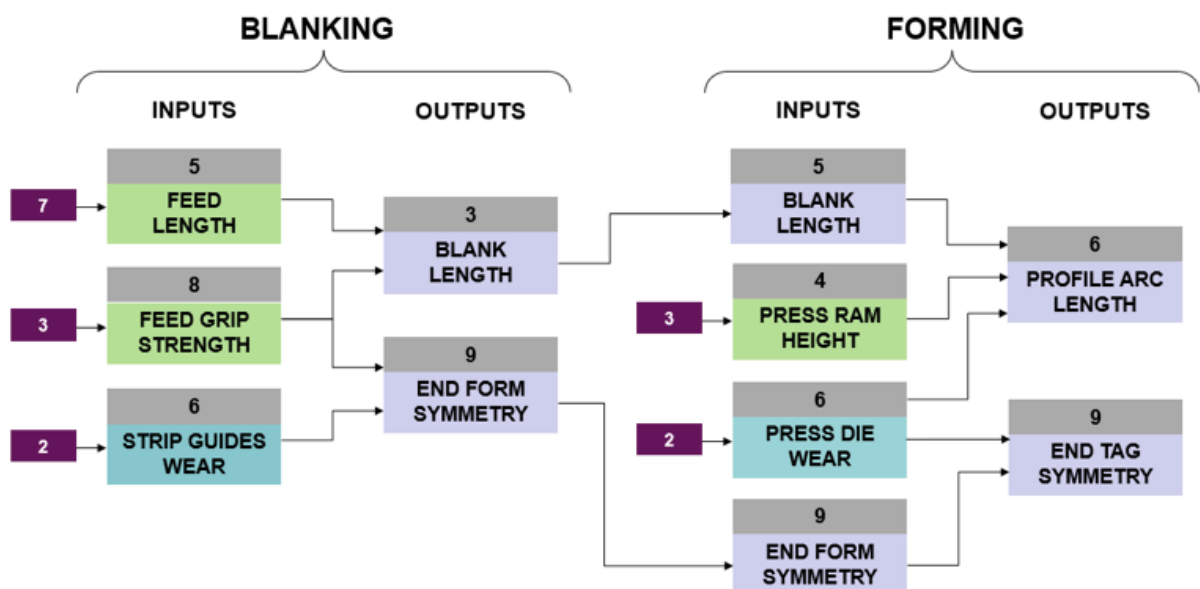

Figure 3: A multi-stage process FFD

### 3.3 Error Chain Analysis

Once a process has been modelled as shown in Fig 3, the percentage values associated with the occurrence and detection can be used to calculate the number of potential undetected errors in the final product. The ECA method assumes that if there is any error with an input feature, there will be an error with the output feature, i.e. the sum of the input errors equals the total errors with the output. For example, if either the feed length is wrong or the feed grip strength is too weak then it is assumed the blank length will be incorrect. A mechanism accounting for cases where an incorrect input leads to a correct output will need to be added in the future. For this demonstration, the output profile arc length from the multi-stage process. Fig. 4 shows part of the percentages for occurrence and detection added to the FFD.

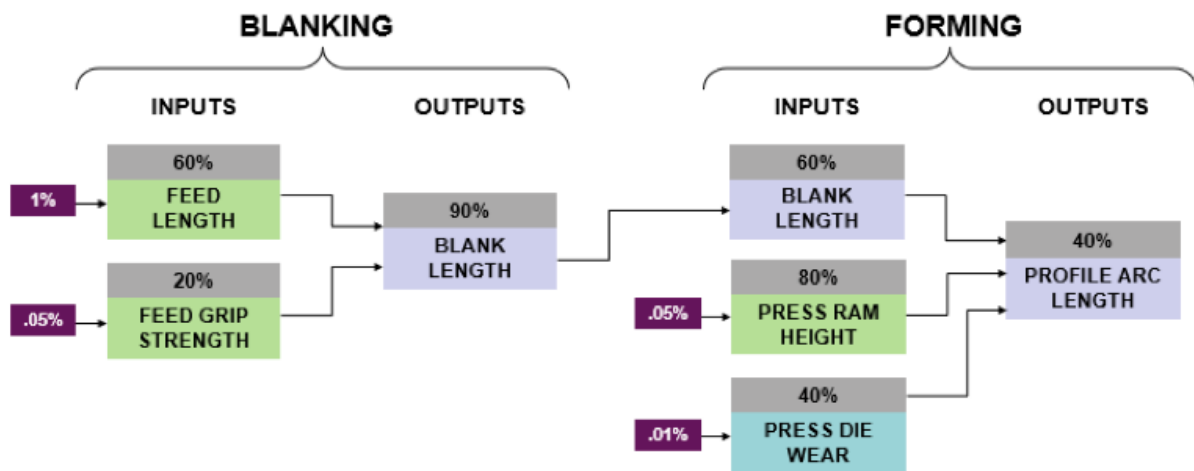

Figure 4: Occurrence and detection percentages added to FFD

To calculate the frequency of undetected errors in an output feature the following equation is used:

$$f_{out} = (D_{out} - 1) \sum_{x=1}^n (f_{in x} \cdot (D_{in x} - 1))$$

where:

$n$ : number of input features

$f_{in}$ : frequency of error occurrence with input feature (as percentage)

$D_{in}$ : percentage of errors that are detected by input control

$f_{out}$ : frequency of error occurrence with the output feature (as percentage)

$D_{out}$ : percentage of errors that are detected by output control

Example:

Calculating the frequency of undetected errors with the blank length that are output from the blanking process:  $f_{out} = (0.9 - 1)(0.01(0.6 - 1) + 0.0005(0.2 - 1)) = 0.044\%$

By using ECA, the exact value for undetected errors in each feature of a product can be calculated as shown in Fig.5.

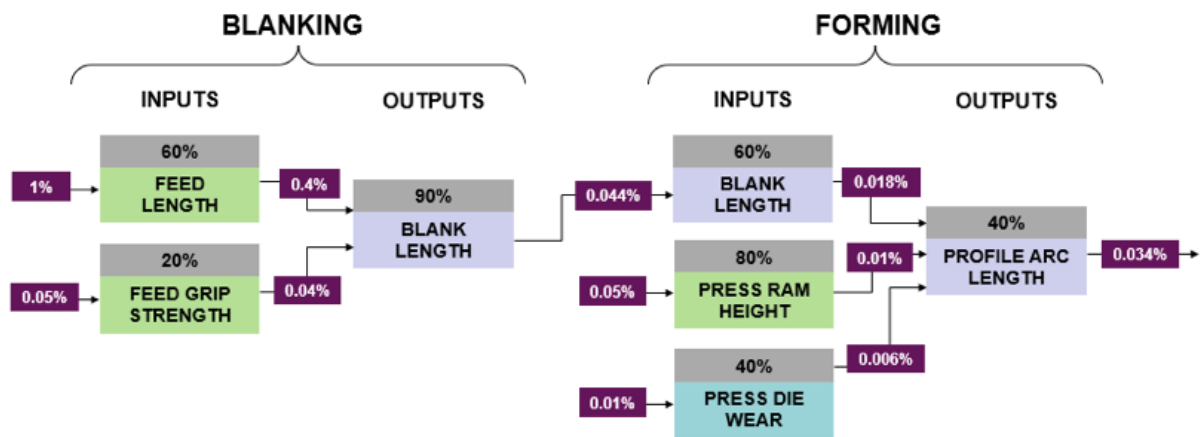

Figure 5: Complete FDD

Table 2 shows the ECA results in terms of percentage of products with an undetected error and the total number of undetected errors that are expected per million parts in the final product in response to each input or output feature at different stages of blanking and forming process.

Table 2: ECA results

Stage	Type	Category	Name	Percentage of products with an undetected error	Undetected errors per million parts
Blanking	Input	Set Up	Feed length	0.4%	400000
Blanking	Input	Set Up	Feed grip strength	0.04%	40000
Blanking	Output	Product	Blank length	0.044%	44000
Forming	Input	Product	Blank length	0.018%	18000
Forming	Input	Set Up	Press ram height	0.01%	10000
Forming	Input	Condition	Press die wear	0.006%	6000
Forming	Output	Product	Profile arc length	0.034%	34000

### 3.4 Control Implementation

By breaking down the problem into steps, ECA can be used to assess quality control throughout and even complex, multi-stage process, presenting results in relatable and intuitive terms.

#### Basic Tactical Control Implementation:

Once ECA has been performed on the whole of a process, a large table of results will be available for assessment. The simplest approach to improving the quality of a process would be to improve the control on the features that produce the most undetected errors. However, this approach is not much different to FMEA, highlighting the worst areas and targeting them for improvement.

#### Intelligent Tactical Control Implementation:

Using ECA to find the exact area of a manufacturing process where an improvement to quality control would have the greatest impact, the value of every detection level should be changed one at a time, having a computer recalculate the entire error chain after each change. Therefore, to find the single most important area to improve control, computational analysis is required.

1. The chain of equations should be programmed to automatically recalculate when any of the detection or occurrence levels are altered.
2. Analysis can be performed to find the most important control to improve by changing the detection level separately for every feature in the entire process. The feature that decreases the value of the total errors in the final product by the greatest amount is therefore the most important feature to improve control on.

Crucially, unlike other methods that attempt this, the calculations required are simple enough that they do not require advanced software or high computational power. This method can in fact be performed in spreadsheet on a standard specification computer as explained in the results section.

#### *Tactically Implementing Control Strategy:*

After a process has been surveyed, it will be split up into stages, every key feature has been reviewed, and data input and actual errors have been calculated – tactical implementation of new controls no longer requires human decisions. For instance, if a quality strategy has been developed for a business and they need to improve the quality from 98% to 99.9%, the ECA method can inform exactly how to achieve this in the most efficient manner.

## **4 Implementation of ECA**

A computational solver tool<sup>1</sup> was developed using only standard Excel features. The tool is capable of carrying out computational means-ends analysis to generate heuristics to mathematically optimise the data. It is also capable of finding a solution subject to constraints, which provides the tool greater utility. Example constraints in the context of the case study are:

- Only improve detection levels on a certain number of features
- Only improve detection by a certain amount of levels
- Only improve detection levels that are currently at a certain level

When run, the solver will attempt to reduce the value for ‘total errors in final product’ by changing only the detection levels of the input and output features while complying with the defined constraints.

### **4.1 Excel Solver Constraint Testing**

The abilities of the developed tool were tested by using existing constrained optimisation problems to verify that it could find the correct solutions. The constrained Rosenbrook function used by Simionescu and Beale (2004) is as follows:  $f(x, y) = (1 - x)^2 + 100(y - x^2)^2$

Subject to:  $(x - 1)^3 - y + 1 \leq 0$  and  $x + y - 2 \leq 0$

The solver was targeted to find a solution within the search domain, as illustrated in Figure 6:

---

1

Available upon request.

$$-1.5 \leq x \leq 1.5 \text{ and } -0.5 \leq y \leq 2.5$$

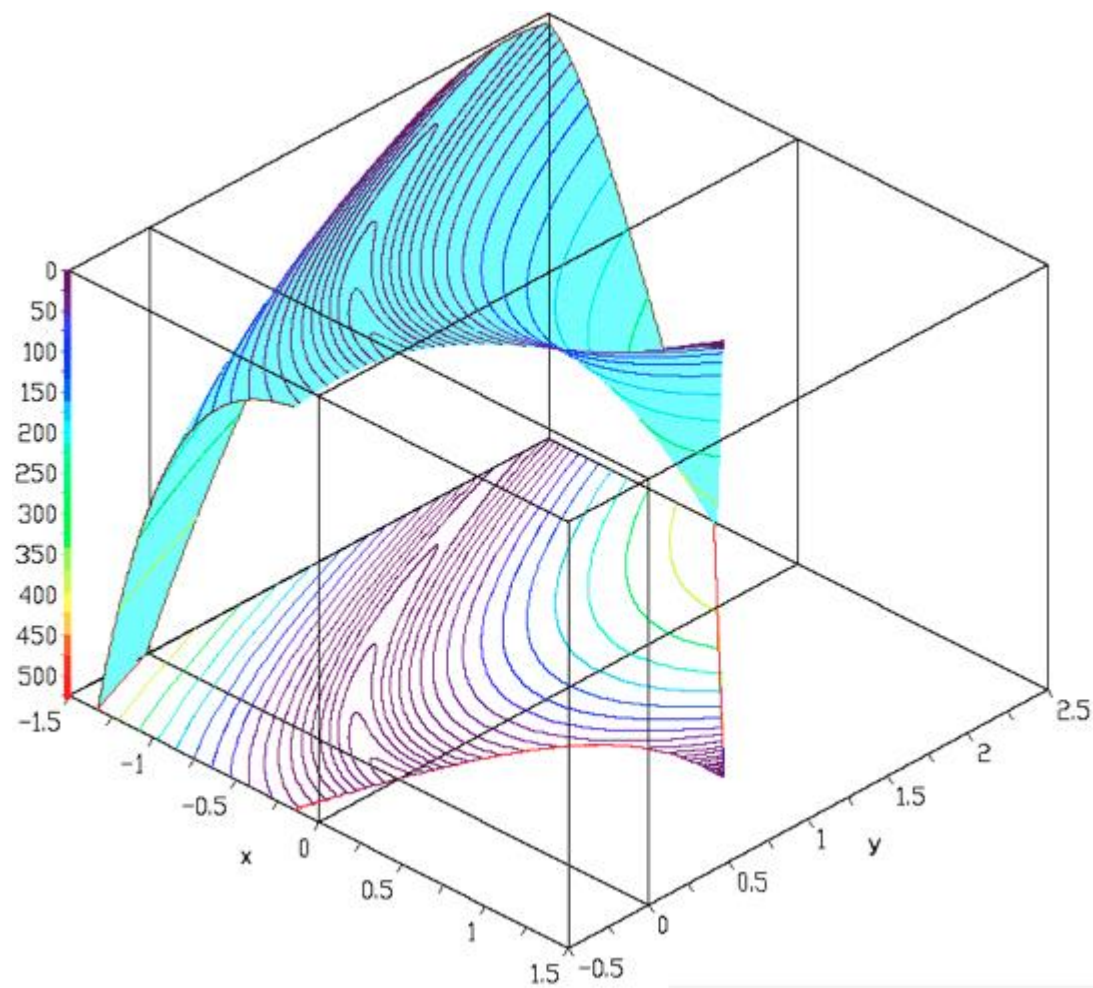

Figure 6: The Rosenbrock function used to test constrained optimization.

The solver found the solution to this problem with very promising speed, always staying under a minute as listed in Table 3.

Table 3: Solver constraint test results

Test Run Number	Line Constraint $(x + y - 2 \leq 0)$	Cubic Constraint $((x - 1)^3 - y + 1 \leq 0)$	Both Constraints Applied
1	12 seconds	29 seconds	36 seconds
2	11 seconds	33 seconds	38 seconds
3	12 seconds	34 seconds	41 seconds
4	12 seconds	31 seconds	39 seconds

## 5 Case study: Modelling VPP 096 clamps manufacture

ECA was applied to a multi-stage manufacturing process used in the case study company. The results were discussed with the manufacturing director and the head of the quality department, and their feedback was very encouraging. They both confirmed that ECA will be used from now on to direct where to step up control. They are implementing it in the company because it gives them the confidence that their implemented changes are having the greatest effect for the least cost / hassle.

The manufacturing process for making VPP 096 clamps can be broken down into the following stages, as shown in Figure 7:

- **Profile Blanking:** Blanking press cuts strips of steel to length and crops the ends
- **Clip Blanking:** Blanking press cuts clip shape from steel
- **Profile Forming:** Forming press shapes blanks into clamp halves
- **Deburring:** Rumbling machine removes sharp edges
- **Profile Crimping:** Crimping tool bends profile edges
- **Clip Welding:** Auto spot welder joins clamp halves and clip
- **Assembly & Packing:** Screw and washer fitted and then clamps are boxed

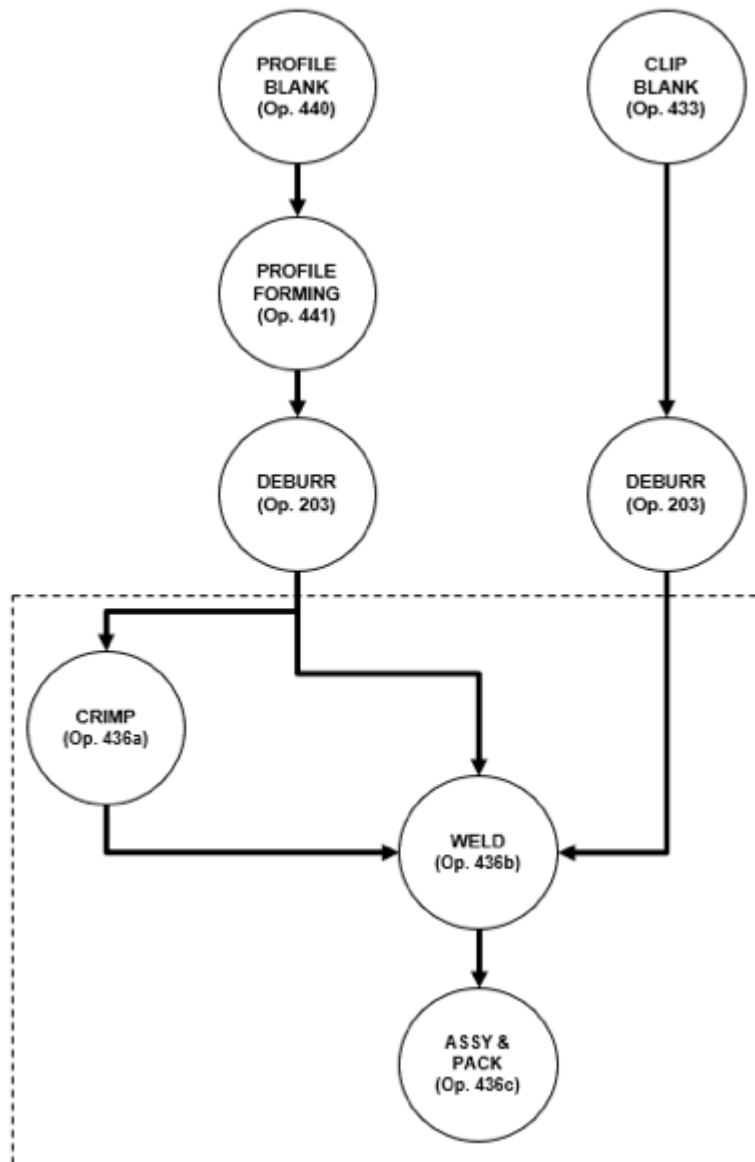

Figure 7: The VPP 096 Clamps processing flow diagram

A survey was carried out for each process stage and every input and output was identified, approximately 40 features of input and output for each stage<sup>2</sup>.

### 5.1 Survey of Detection Levels

A survey of the detection levels was carried out on every identified feature, in compliance with Ford Design Institute FMEA standards. The results of this survey can be found in Dockree (2019); occurrence levels were not re-surveyed in this study. The values for occurrence were extracted from existing PFMEA documents of the case study company.

<sup>2</sup> Dockree (2019) provides a full breakdown in Tables 7.1 to 7.7.

## 5.2 Error Chain Analysis

Once the data had been collected, it was imported into the developed solver tool and ECA could be carried out. This was a lengthy process as every input and output feature needed to be linked to all dependent features. The relevant data can be found in Dockree (2019: Table 7.8). Once completed, the results of the ECA can provide the total undetected errors that are produced at each process along with the cumulative undetected errors, as shown in Table 4 where nut crimping, bridge welding, clip welding and assembly and packaging are distinct processes which are performed at the same station. The cumulative undetected errors at each stage include the errors produced at that stage plus any errors produced at a previous stage that have evaded detection up to this point.

Table 4: VPP clamp ECA results

Process	Cumulative undetected errors after each process [per million parts made (pmpm)]	Undetected errors produced by each process [pmpm]	Total undetected errors + detected errors after each process [pmpm]
Profile Blanking	6573	6573	11998
Profile Forming	8556	8036	41868
Profile Deburring	13068	5268	49397
Bridge Blanking	13657	589	50607
Nut Crimping	14024	2437	61841
Bridge Welding	15149	4134	75593
Clip Welding	14538	1136	79352
Assembly & Packing	12805	1393	83071

Figure 8 shows the errors that take place at each stage of the process. It includes the undetected errors in blue and the cumulative undetected errors in red and sum of undetected errors and detected errors in grey. To help visualise the impact of the detection controls currently in place.

As is the case in this VPP production process, the total number of undetected errors in a product can decrease as additional manufacturing stages are carried out. At first this can seem counterintuitive. However, this is because although more errors are added, existing ones can be detected and eliminated at subsequent stages. For example, there may be 10000 undetected errors per million parts made (pmpm) present in the formed profiles which remain undetected until the last stage when the profiles are fitted into a jig for assembly. At this point many of the existing errors with the profile form are detected and eliminated. In fact, more errors are eliminated at this stage than added.



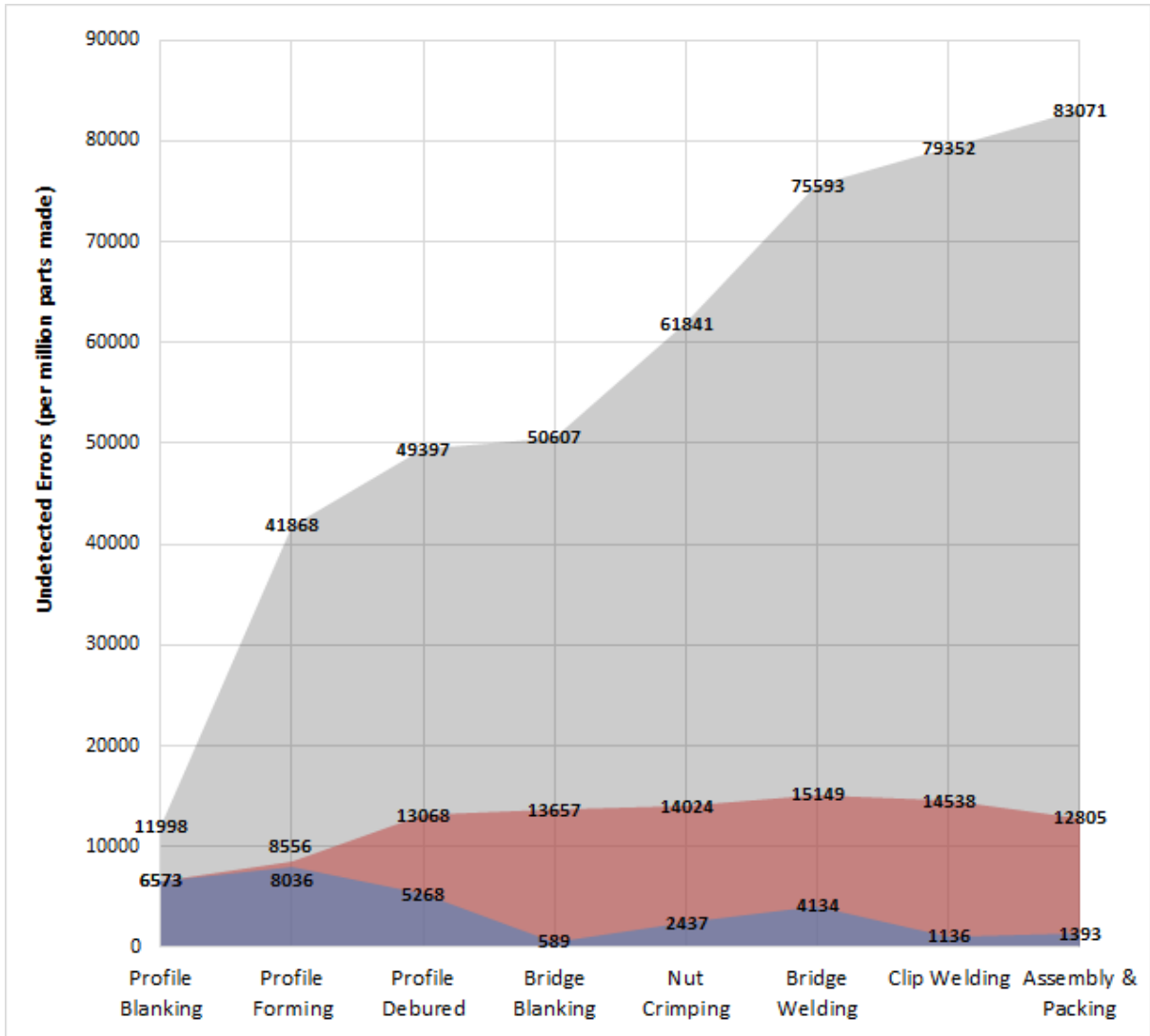

Figure 8: Errors present at each stage of production of a VPP clamp with an overhead clip. In blue: Undetected errors produced by each process. In red: Cumulative undetected errors after each process. In grey: Total undetected errors + detected errors after each process.

### 5.3 Suggested Control Improvements based on the ECA

After the ECA had been completed, the solver was able to run and find features that would reduce the total undetected errors in the process based on the following constraints applied:

- Only improve the detection levels of the feature by 1 level
- Examine the entire process i.e. no constraint on the process stages reviewed
- Find the top five best features

The suggested improvements are shown in Table 5, together with an indication of the control level before and after. This then translates into suggested improvements for tighter quality control.

Table 5: Results from solver analysis (suggested control improvements)

Features Improved		From
Input product feature:	Uniformity of crimped profiles batch (no mixed parts)	5
Output product feature:	Bottom gap (above spec)	6
Output product feature:	Blank length (too short)	6
Input set up feature:	Nut loading	5
Output product feature:	Number of clamps count (too many or too few)	5

Example breakdown of a recommendation:

**Recommendation:** Change the existing level 5 control on the input setup feature of “Nut loading” to a level 4 control.

**Existing Control:** A level 5 control is “Continuous gauging of feature (gauge built into jig/adjustable strip guides).” The actual control in place is a jig - every nut is loaded into a jig for assembly.

**Improved Control:** The suggested improvement is to a level 4 control which is “Continuous gauging of feature and routine thorough checks.” In other words, the suggestion is to also have a routine thorough check of the completed parts as well as the currently used loading jig. By routinely checking the completed parts at this stage if the jig has become misaligned it will be recognised and the error will be eliminated.

The Excel tool then automatically recalculates the ECA using these suggested improvements to control. On this basis, if these highlighted improvements are made, it is calculated that there would be a 22.3% increase in production quality (as shown Table 6).

Table 6: Case study results – calculated improvement in quality

Total Undetected Errors (per million parts)	
Before improvement	After Improvement
12805	9945

## 6 Discussion and Conclusion

The results of this study demonstrate that the control of a complex manufacturing process can be analysed providing a quick solution in levels of controls that can subsequently be generated using a simple ECA approach, which is presented and illustrated in this paper. This is a very useful tool for achieving the tactical implementation of controls for manufacturing companies facing a similar issue. The solver tool, which was built only using Excel, was able to identify the top 5 points in a manufacturing process that most require tighter control. With this, a quality target can be met in the most efficient way possible and without any prior knowledge or experience of the process.

However, this tool does not consider the cost of implementation / improvement of controls, which can result in the suggested improvements being impractical or too costly. Fortunately, by merely changing the constraints applied to the tool, impractical improvements can be ignored. This means that if a suggestion cannot be implemented, a constraint can be added to exclude that feature from the calculation. For example, if it is too expensive to consider implementing level 1 or 2 controls at any stage of a process then the solver can be told to only improve a control to a maximum of level 3. Therefore, with the simple addition of constraints, this analysis method and solver tool can suggest the best improvements for any manufacturing process.

Testing was successfully run on data gathered from a process with 7 stages each with approximately 40 input and output features that were all intricately interlinked. The solver managed to correctly identify the top 5 features that would benefit from greater control. It is hoped that this method could be a better option than FMEA which is commonly used to assess the reliability of a system. Instead of producing an arbitrary Risk Priority Number, ECA produces exact values for the number of defects that are expected to be produced per number of parts made. However, to fully supersede FMEA, this computational method will also need to incorporate the severity of failure as well as occurrence and detection.

ECA was created with a set of criteria as outlined in the introduction. Reviewing these criteria, we can conclude the following: ECA provides an accurate assessment of the level of control that exists in a process and the chance of failure of these controls. It is capable of identifying potential sources of failure from known and unknown combinations of errors, and it can provide an exact answer to the question: "Where is it best to increase control and by how much?" ECA does not require advanced software tools, or complex mathematical analysis, which are all barriers to implementation for operators in the manufacturing industry. It is capable of analysing an entire multi-stage manufacturing process as a whole instead of focussing on each stage separately, and it works based on both estimated "predictive" data and collected "reactionary" data.

## Acknowledgement

The authors wish to thank the key colleagues who assisted the first author in this project at the case study company, whose name must remain confidential, for supplying the technical support throughout this research-based project.

## References

- Akgün, İ., Gümüşbuğa, F., & Tansel, B. (2015). Risk based facility location by using fault tree analysis in disaster management. *Omega*, 52, 168-179. doi: 10.1016/j.omega.2014.04.003
- Antony, J., E.V. Gijo & S.J. Childe (2012) Case study in Six Sigma methodology: manufacturing quality improvement and guidance for managers, *Production Planning & Control*, 23:8, 624-640, DOI: 10.1080/09537287.2011.576404
- Banduka, N., Veža, I., & Bilić, B. (2016). An integrated lean approach to Process Failure Mode and Effect Analysis (PFMEA): A case study from automotive industry. *Advances in Production Engineering & Management*, 11(4).
- Brady, J., & Allen, T. (2006). Six Sigma Literature: A Review and Agenda for Future Research. *Quality And Reliability Engineering International*, 22(3), 335-367. doi: 10.1002/qre.769
- Brun, A., & Savino, M. M. (2018). Assessing risk through composite FMEA with pairwise matrix and Markov chains. *International Journal of Quality & Reliability Management*, 35(9), 1709-1733.
- S. Davrajh & G. Bright, (2013) "Advanced quality management system for product families in mass customization and reconfigurable manufacturing", *Assembly Automation*, Vol. 33 Issue: 2, pp.127-138, <https://doi.org/10.1108/01445151311306636>

- Dockree, J. (2019). An Engineering Approach to the Understanding and Control of Quality in a Manufacturing Process. BEng Thesis, University of Portsmouth, UK. Available online: [https://drive.google.com/open?id=1MFM5\\_cjK9qCWhLGMP3IePbcFTyIAeqc1](https://drive.google.com/open?id=1MFM5_cjK9qCWhLGMP3IePbcFTyIAeqc1)
- Ford Design Institute (2011). *Ford FMEA Handbook: Version 4.2*. Dearborn, Michigan.
- Gordon, J. (2019). What Are the Disadvantages of SPC. Retrieved from <https://yourbusiness.azcentral.com/disadvantages-spc-29086.html>
- Hamrol A (2000) Process diagnostics as a means of improving the efficiency of quality control, *Production Planning & Control*, 11:8, 797-805, DOI: 10.1080/095372800750038409
- Johnson, K., & Khan, M. (2003). A study into the use of the process failure mode and effects analysis (PFMEA) in the automotive industry in the UK. *Journal Of Materials Processing Technology*, 139(1-3), 348-356. doi: 10.1016/s0924-0136(03)00542-9
- Joshi, G., & Joshi, H. (2014). FMEA and Alternatives v/s Enhanced Risk Assessment Mechanism. *International Journal Of Computer Applications*, 93(14), 33-37. doi: 10.5120/16284-6047
- Karuppusami, G., & Gandhinathan, R. (2006). Pareto analysis of critical success factors of total quality management. *The TQM Magazine*, 18(4), 372-385. doi: 10.1108/09544780610671048
- Michalakoudis I, Aurisicchio M, Childs P, Koutlidis A and Harding J (2018) Empowering manufacturing personnel through functional understanding, *Production Planning & Control*, 29:8, 688-703, DOI: 10.1080/09537287.2018.1455995
- F. Mhada, A. Hajji, R. Malhamé, A. Gharbi, R. Pellerin, (2011) "Production control of unreliable manufacturing systems producing defective items", *Journal of Quality in Maintenance Engineering*, Vol. 17 Issue: 3, pp.238-253, <https://doi.org/10.1108/13552511111157362>
- Oakland, J. (2008). *Statistical process control* (6th ed.). Burlington: Butterworth-Heinemann.
- Ong KH, Harvey CM, Shehab RL, Dechert JD and Darisipudi A (2004) The effects of three statistical control charts on task performance, *Production Planning & Control*, 15:3, 313-323, DOI: 10.1080/09537280410001702137
- Ordieres-Meré, J., González-Marcos, A., Alba-Elías, F., & Menéndez-Fernández, C. (2012). Advanced predictive quality control strategy involving different facilities. *The International Journal Of Advanced Manufacturing Technology*, 67(5-8), 1245-1256. doi: 10.1007/s00170-012-4562-9
- Pantazopoulos, G., & Tsinopoulos, G. (2005). Process failure modes and effects analysis (PFMEA): A structured approach for quality improvement in the metal forming industry. *Journal Of Failure Analysis And Prevention*, 5(2), 5-10. doi: 10.1361/15477020522933
- H. Paul and P.S. Yan, (1984) "Quality Control and Reliability Management - The Role of Production Engineers", *International Journal of Quality & Reliability Management*, Vol. 1 Issue: 1, pp.31-38.
- Rissik, H. (1943). *Quality Control in Production Engineering, Aircraft Engineering and Aerospace Technology*, Vol. 15 Issue: 3, pp.85-90, <https://doi.org/10.1108/eb031001>
- Rossiter, J. A. (2017). *Model-based predictive control: a practical approach*. CRC press.
- Ross, J. E. (2017). *Total quality management: Text, cases, and readings*. Routledge.
- Roy, R. K. (2010). *A primer on the Taguchi method*. Society of Manufacturing Engineers.
- Ruijters, E., & Stoelinga, M. (2015). Fault tree analysis: A survey of the state-of-the-art in modeling, analysis and tools. *Computer science review*, 15, 29-62.
- Shewhart (1926). *Quality Control Charts*, *The Bell System Technical Journal*, Volume 5, Issue 4, p. 593-603.

- Simionescu, P., & Beale, D. (2004). Visualization of hypersurfaces and multivariable (objective) functions by partial global optimization. *The Visual Computer*, 20(10), 665-681. doi: 10.1007/s00371-004-0260-4
- Tsou JC and Chen JM (2005). Case study: quality improvement model in a car seat assembly line, *Production Planning & Control*, 16:7, 681-690, DOI: 10.1080/09537280500249223
- Woodall, W. (2000). Controversies and Contradictions in Statistical Process Control. *Journal Of Quality Technology*, 32(4), 341-350. doi: 10.1080/00224065.2000.11980013
- LY Zheng, KS Chin & L Wei, (2002) "Knowledge-enriched Process FMEA Model For Process Planning", *Asian Journal on Quality*, Vol. 3 Issue: 1, pp.12-27, <https://doi.org/10.1108/15982688200200002>